

ORTHOPHOS XG<sup>Plus</sup> DS/Ceph



X-ray systems

## ORTHOPHOS XG<sup>Plus</sup> – Digital Imaging perfection



The Dental Company

sirona.



# ORTHOPHOS XG<sup>PLUS</sup>

> I rely upon Sirona, the market leader in digital X-ray systems. <

Carolin Bader, 43 years, dentist

# ORTHOPHOS XG<sup>Plus</sup> — Digital Imaging with Confidence.

## Operational Simplicity

### Operational Simplicity

- Efficient patient positioning
- Intuitive operation with “Easypad” touch screen
- Interactive messages for operator



## Reliable Diagnosis

### Reliable Diagnosis

- Clear program logic
- Practical diagnostic possibilities
- Automatic, patient-specific exposures

## Investment Security

### Investment Security

- Practice-proven optimal workflow
- Upgradeability Ceph / TSA
- Future software upgrades

## ORTHOPHOS XG<sup>Plus</sup> – consistent, high-quality images through operational simplicity.



> Everything is so well designed, Sirona eliminates the guesswork and makes our office more productive. <

*Intuitive, consistent operating system.* The new "Easypad" – a graphical user interface with a full-color touch screen – makes selection of programs or special functions easier than ever. The "Easypad" provides all the necessary information, e.g. bite block selection and patient positioning guidance. The adjustment of the collimator and the orbital curve occurs automatically.

*As individual as your patients and your treatment plans.* The program settings adapt to the patient based upon the built-in positioning and measurement features. Additional fine-tuning is intuitive, fast and easy.

*Immediate feed-back.* The image is instantly available on the "Easypad" screen for control. The image remains stored in the unit's internal memory until it is safely passed through the network and into the office imaging database.

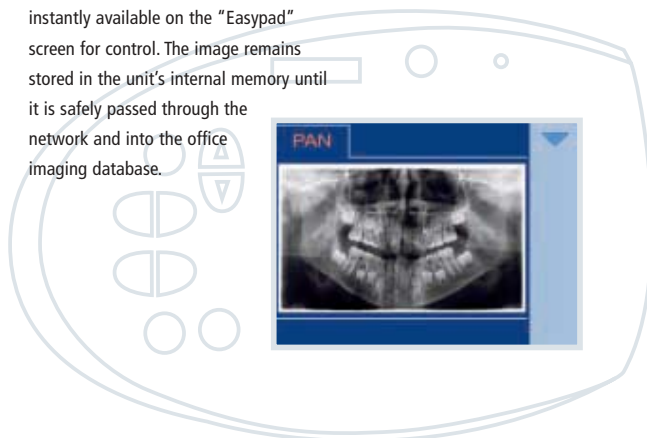

# ORTHOPHOS XG<sup>Plus</sup> – reliable diagnosis at its finest.



> For my most important diagnostic tool,  
I rely upon Sirona's easy-to-use, advanced  
technology. <

### Self-explanatory!

The ORTHOPHOS XG<sup>Plus</sup> provides strong  
diagnostic benefits with its unique  
"Quality Image Process (QIP)":

- Fast and precise positioning in the sharp image layer
- Comfortable stabilization prevents blurring
- Optimized X-ray dose management
- Refined focal layers for individual orbital curves
- Ease of operation
- Rapid image processing

Details are provided in the enclosed table.



## The "Quality Image Process" "QIP" by ORTHOPHOS XG<sup>Plus</sup>.

### Precise positioning

The jaw must be exactly in the sharp image layer!

- As for all Sirona panoramic equipment only two layers have to be adjusted. The mid-sagittal plane and the Frankfurt horizontal plane are aligned quickly using two laser positioning lines and the dark line on the bite block. The patient's front teeth are placed correctly in the bite block establishing the first reference point – immediately, exactly, without a third light beam and the opportunity for subjective misinterpretation.

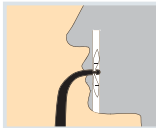

- The ORTHOPHOS adapts the orbital curve to the patient's jaw size via the temple support so that the molars are in the range of optimal focus.

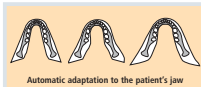

In special cases one-step fine-tuning of the anterior jaw shape is possible.

### Comfortable stabilization

If the patient is positioned exactly in the layer, movement blurring is avoided.

- The patient looks towards the unit, into the mirror, not towards the staff. That prevents the eyes from following the staff when leaving the room.
- The 3-point fixation with bite block, forehead and temple support prevents movements and provides comfortable patient fixation.



- With the 3-point fixation the position of the patient is exactly determined and the measurements and settings will be saved for reproducing later X rays using identical conditions.

### Optimized X-ray source

The image quality will be influenced by the radiation management:

- Consistent X-ray beam with high-frequency generator
- Automatic exposure control for adaptation of the radiation to different bone and tissue densities
- Automatic increase in kV radiation quality, not quantity for spinal column compensation to maximize image quality in the anterior region
- Exposure parameters built on the experience of more than 40,000 Sirona panoramic X-ray units in operation provide preset value pairs (kV/mA settings)
- "Quickshot" available as an option for Panoramic / Ceph using the "Easypad"

### Refined focal layers

For specific diagnostic needs different panoramic programs of the ORTHOPHOS XG<sup>Plus</sup> can be selected, e.g.:

- **"Standard" (orthoradial):** Fundamental diagnostic tool that provides clear images of full dentition with minimized overlapping
- **Artifact-free:** The focal path is offset slightly to avoid double projection of shadows, i.e. caused by metallic items in the patient's posterior teeth
- **Constant magnification (1.25)** For implant planning and diagnosis the focal path is modified slightly to keep the magnification factor at a constant 1.25 to 1

Other examples:

- Thick layer in the anterior region for anomalies (P12)

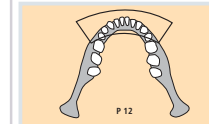

- Programs for lateral and axial TMJ views with specific radiation direction and special orbital curve

### Ease of operation

Save time, avoid uncertainties, and eliminate misinterpretation!

- Panoramic unit accommodates standing patients up to 6'7" tall
- Immediate and exact patient positioning in the frontal layer without a 3rd light localizer
- Automatic adjustment of the focal layers to the jaw size
- Easy selection of the exposure parameters and programs with the "Easypad"
- Image control on the "Easypad"



- Automatic collimator adjustment with program selection
- Combination Pan/Ceph or Pan/Ceph/TSA sensors are optional
- Save time on control images due to saved positioning data and exposure parameter

### Rapid image processing

ORTHOPHOS XG<sup>Plus</sup> CCD sensors have a pixel size of 27 µm for Pan and Ceph.

- Special wide sensor technology for transversal sections based on wide-beam tomography provides very thin (< 1 mm) slices
- The image is captured using a 16-bit system and automatically pre-processed to get the optimum quality image. Example: to see even the finest detail the image is shown at the highest number of greyscale between black and white regardless of over- or underexposure
- The image data is stored in the ORTHOPHOS XG<sup>Plus</sup> until it is passed through the network and into the office imaging database

- Another advantage: the ORTHOPHOS XG<sup>Plus</sup> directly integrates into the office network: it does not require a dedicated PC – all PCs on the network can access the images and make the system ready for an exposure as long as they have SIDEXIS XG installed

The result is viewed with SIDEXIS XG (see also pages 18–19).



# ORTHOPHOS XG<sup>Plus</sup> – intuitive program selection for reliable diagnosis.

Quick selection of programs (example: PAN P1) and the exposure parameters via simple icons!

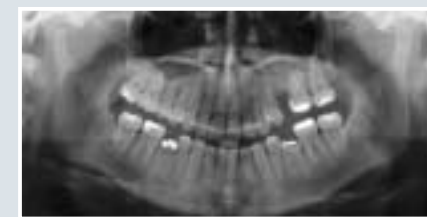

*Always the right choice!*  
The ORTHOPHOS XG™ "Easypad" menu assists with correct program and function selection. PAN programs can be specified as standard or modified to provide constant magnification (for implant planning) or modified to reduce artifacts.

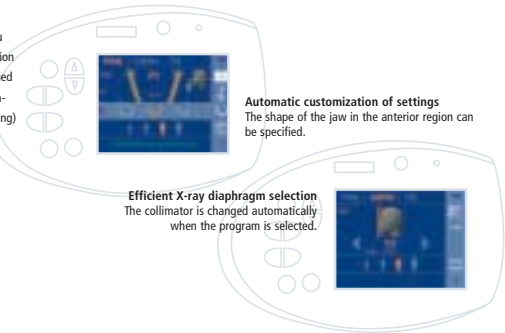

**Automatic customization of settings**  
The shape of the jaw in the anterior region can be specified.

**Efficient X-ray diaphragm selection**  
The collimator is changed automatically when the program is selected.

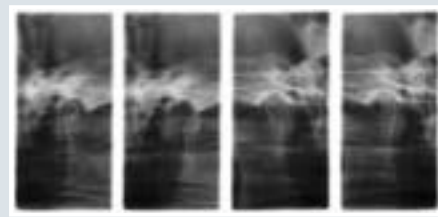

- P1
- P2
- P10
- P12
- TM1
- TM3
- TM5
- S1
- S2

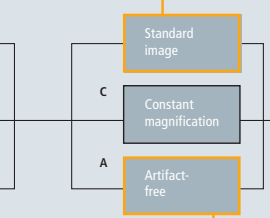

P1

TMJ lateral\*

Sinus

TMJ axial\*

TM2

TM4

TM6

TS 1

P1A

\* Closed and open occlusion: single layer or multilayer TMJ exposures

Transversal multilayer Posterior teeth

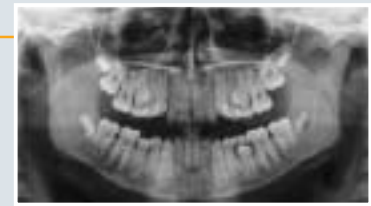

Selection of exposure area is possible

Further programs:  
transversal sections (TSA) based on wide-beam tomography: see page 14/15  
cephalometric X ray: see page 16/17

# ORTHOPHOS XG<sup>Plus</sup> – transversal sections as thin as never before.



*Transversal multilayer:* Every ORTHOPHOS XG<sup>Plus</sup> has a program to show transversal images in the posterior region with a thick layer (program TS1).

*Exclusively with Sirona: digital wide-beam tomography (TSA) option!* Extremely thin layers in a second dimension. Only for the ORTHOPHOS XG<sup>Plus</sup> / Ceph a special wide sensor is available for transversal sections with a thickness less than one millimeter. This technique gives reliable information and confidence in the diagnosis. It is of course possible to show every tooth with TSA.



*Patient-positioning is fast and precise using the Sirona TSA ruler:*

1. Measure the distance between the patient's anterior teeth and the area in which the exposure is to be taken.
2. Select the area.
3. Key the distance values, using the "Easypad" into the ORTHOPHOS XG<sup>Plus</sup> and the machine will handle the rest.

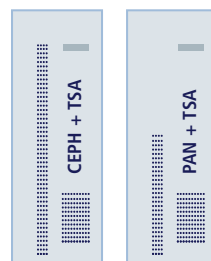

*The result:* Informative images with low depth of focus due to the special sensor. The method is logical and easy due to the integration of the wide TSA sensor into the housing of the Pan or Ceph sensor.

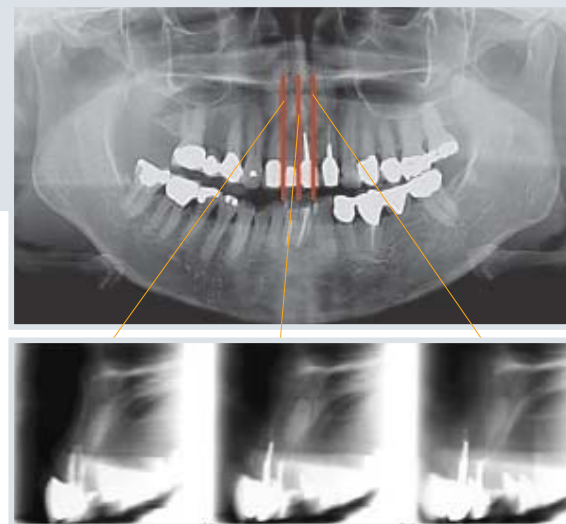

Extra tooth in the front of the upper maxilla.

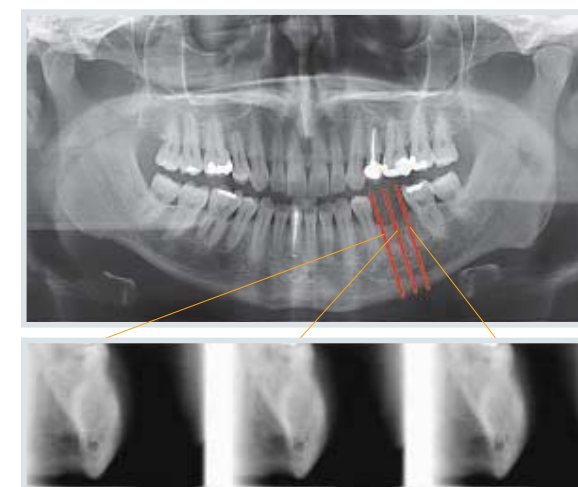

Optimal visibility of the mandibular channel due to good positioning of the edge of the mandible during the exposure.

# ORTHOPHOS XG<sup>Plus</sup> Ceph – cephalometric X ray with a vision.



*ORTHOPHOS XG<sup>Plus</sup> Ceph* is the optimal unit for orthodontists and oral maxillofacial surgeons. Scanning technique combines high-resolution images with low dosage. The image width can be 18 cm or 30 cm depending upon your preferences. In addition to the standard programs for lateral, symmetrical (PA/AP) and hand/wrist images other special exposures such as sub-mental vertex are possible. Cephalometric unit accommodates standing patients up to 6'3" tall.

The principal of horizontal scans:

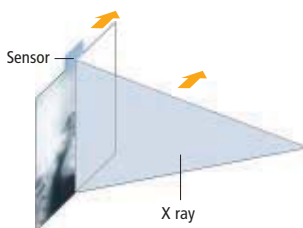

*Perfectly adapted!*

The ORTHOPHOS XG<sup>Plus</sup> Ceph is adaptable to your unique patient needs and the special workflow of the orthodontic practice:

■ **Panoramic images**

Children can be X-rayed with the lowest possible dose using program 10 which has a smaller, correctly shaped focal path (the exposure area is smaller in width and height). Program 12 provides a thick focal layer in the anterior region for extreme anomalies. Automatic adaptation of the focal layer to align with various shapes of the patient's jaw is also available.

■ **Panoramic and cephalometric X rays**

With the option "Quick Shot", automatic diaphragm adjustment and controllable Pulse/Pause ratio, shorter exposure cycles are achieved. For more workflow advantages, see also pages 20/21.

■ **Shorter exposure cycles**

The function Panoramic, Cephalometric, Hand/Wrist (Carpus) as a group allows shorter cooling time between exposures.



Lateral cephalometric image with activated soft tissue filter and Quickshot



The cephalometric attachment can be added later. From Pan to Ceph without sensor exchange: the unit can be operated optionally with 2 sensors as well.

# SIDEXIS XG imaging software – the perfect complement for the ORTHOPHOS XG<sup>Plus</sup>.



> A well-balanced interaction of all elements. <

*A new look and feel!* SIDEXIS XG imaging software makes it possible to diagnose and annotate your X-ray images easily. SIDEXIS XG is compatible with most practice management software systems and special programs (e.g. orthodontic analysis and tracing software). DICOM is also supported. SIDEXIS XG ties the elements of the Sirona digital practice together: digital intraoral X ray, digital panoramic and cephalometric X ray, SIROCAM intra-oral camera.

*Fast and productive!* With SIDEXIS XG all diagnostic findings and treatments can be clearly and easily documented. By combining images, measurements, drawings and annotations into an "Examination" everything becomes clearer to the patient and treatment acceptance improves.

*Individual!* The user interface can also be adapted individually. Filters, brightness and contrast settings can be automatically pre-selected. This means fewer "clicks" and less time.

*Treatment-oriented!* With the button "examination" images, diagnosis and notes can be recalled and actualized for each case. Everything in correct order and always available immediately on demand.



**Digital panoramic X ray:** Fewer computers, more flexibility: ORTHOPHOS XG<sup>Plus</sup> can be connected directly to a network and does not need to be connected to a dedicated computer.



**Intraoral X-ray stations, the connectors for intraoral sensors:**

- X-ray box, directly mounted to C<sup>+</sup> treatment centers
- Wall box, to be connected directly to the network
- USB Box for portable applications

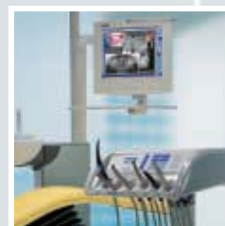

**Better patient communication** occurs directly at the treatment center with SIVISION and SIDEXIS XG.



## ORTHOPHOS XG<sup>Plus</sup> – higher productivity for the dental practice.



> Efficient workflow ensures my success – that's a good investment. <

*The right choice!* A diagnostic X-ray unit is a capital investment that generates returns for a long time. The ORTHOPHOS XG<sup>Plus</sup> makes the advantages of the digital X ray perfect through workflow optimization.

*Secure operation!* "Easypad" allows intuitive handling without misinterpretation or uncertainty. This is important when operating staff is changing.

*Time-saving!* ORTHOPHOS XG<sup>Plus</sup> reduces the treatment steps through:

- **Faster and precise patient positioning:**  
Only two layers to set instead of three.
- **Automatic diaphragm selection after program selection:**  
The diaphragm will be automatically positioned during program selection.
- **Controllable Pulse/Pause ratio:**  
Shorter multiple-exposure cooling cycles (panoramic, ceph asymmetric, ceph symmetric, Carpus). An advantage for orthodontic practices.
- **"Quickshot" for panoramic and cephalometric exposures:**  
Time-saving at a low dosage.
- **Pan, Ceph and TSA without sensor exchange:**  
Pan and ceph sensors can be used in parallel. The special wide TSA sensor can be integrated.
- **Automatic calibration**

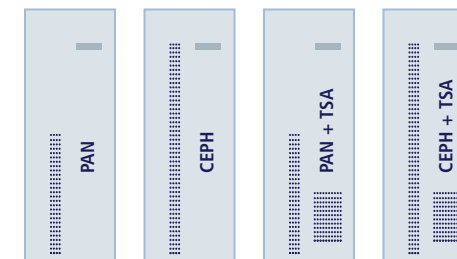

**Maximum freedom:**  
Four sensor alternatives for all cases. When upgrading a sensor exchange is possible.

# ORTHOPHOS XG<sup>Plus</sup> — ready for the future.



> When buying this Sirona digital imaging system today, we are confident that it will meet our goals in the future. <

*An open, flexible platform!* The diagnostic needs of the dental office are always changing. The ORTHOPHOS XG<sup>Plus</sup> system is designed and manufactured to be adaptable when these needs arise.

▶ **Technological power package!** ORTHOPHOS XG<sup>Plus</sup> integrates the most modern technology: integrated power PC-driven operating system, 16-bit image acquisition, high-speed image exchange interface, Can-Bus technology. The value of the current components derives from the capability to handle future technology.

▶ **High-speed sharing!** ORTHOPHOS XG<sup>Plus</sup> uses Ethernet technology; it is directly network-compatible and can therefore be controlled or viewed from any computer on the network. It is not necessary to dedicate a single computer to control the unit. Moreover ORTHOPHOS XG<sup>Plus</sup> is ready for future networks as it already has an internal fiber-optic communication system.

▶ **Flexibility for tomorrow!** The software for the unit can be updated or changed at any time. Additional programs or functions can be added via a simple data exchange. The graphical touch screen of the "Easypad" can be adapted to control future applications through a software update.

▶ **125 years of technological innovation!** Since 1877 Sirona Dental Systems has been a pioneer in the dental equipment industry. Continuing a long history of X-ray innovations, Sirona introduced the first ORTHOPHOS digital pan/ceph unit to the market in 1996. The experience of more than 40,000 units installed worldwide is reflected in the reliability of Sirona X-ray equipment. With the partnership of Sirona authorized dealers and our customer/technical service groups, you can be confident that your investment will provide a strong return on investment for years to come.

▶ **Easily upgradable!** Adding cephalometric X ray or transversal slice acquisition (TSA) is not a problem.

▶ **Esthetic excellence!** The elegant and modern design of the ORTHOPHOS XG<sup>Plus</sup> has already received a design award.

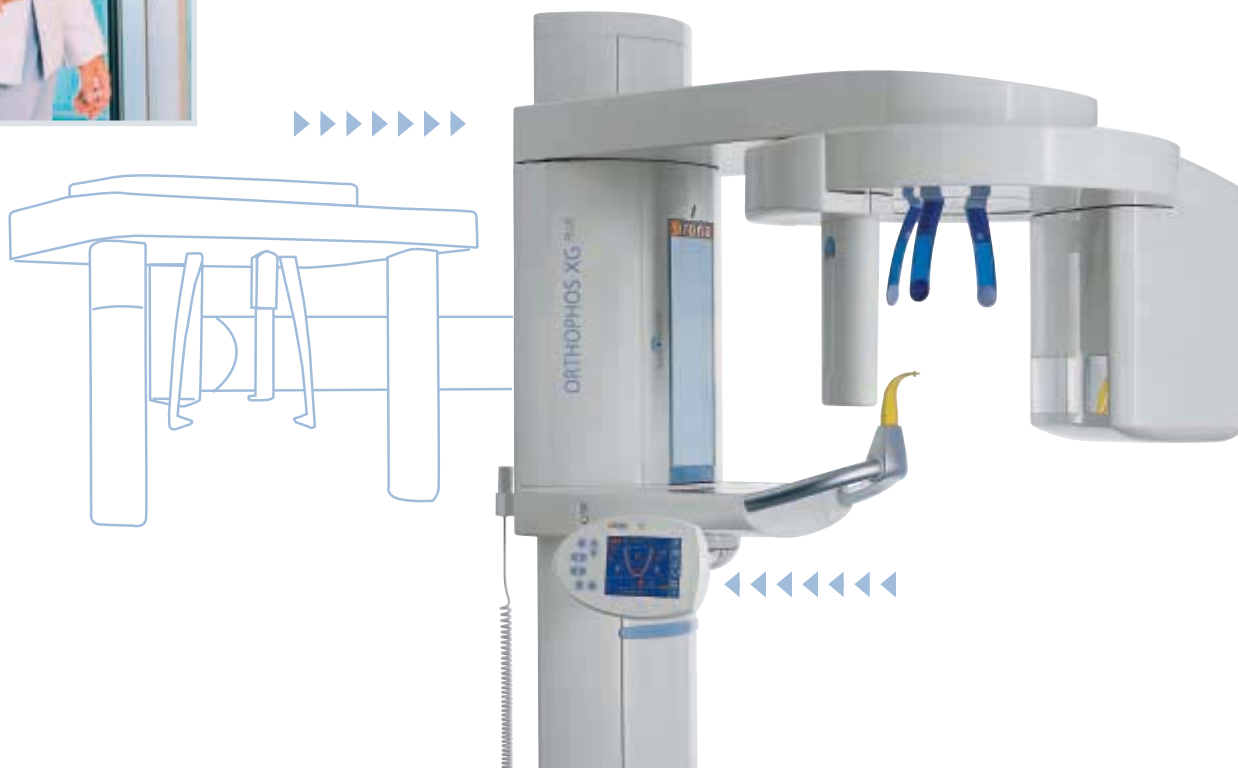

# ORTHOPHOS XG<sup>Plus</sup> – always the right choice.

Technical data	ORTHOPHOS XG <sup>Plus</sup> ORTHOPHOS XG <sup>Plus</sup> Ceph
Radiation generator	Multipulse generator (max. 120 kHz)
X-ray tube	SR 90/15 FN
Focal spot size according IEC 336/82	0.5 mm x 0.5 mm
Total filter	2.5 mm AL
Tube voltage	60–90 kV
Tube current	3–16 mA
Nominal voltage	230 V–240 V, 50–60 Hz
Nominal current	12 A
Line internal resistance	max. 0.8 Ohm
Fuse	16 A slow blow
Power consumption	2.8 kW
Permissible line voltage fluctuations	± 10 %
Panoramic exposure time (P1)	14.2 s
Panoramic exposure time (P1) "Quickshot"	9.1 s
Range of height of bite block	800–1810 mm (2'8"–5'11")
<b>Ceph</b>	
Radiation time	9.4 s
Radiation time "Quickshot"	4.7 s
Effective exposure time	Approx. 270 ms



Optional remote exposure control/display.



Optional baseplate. Accommodates standing and sitting patients and wheelchairs

Technical features
<ul style="list-style-type: none"> <li>Centralized control via "Easypad" with full-color touch screen</li> <li>Intuitive program structure</li> <li>Image preview on the "Easypad" screen</li> <li>Optional remote control</li> </ul>
<ul style="list-style-type: none"> <li>90-kV high-frequency generator</li> </ul>
<ul style="list-style-type: none"> <li>Automatic adaptation of the focal layer to the individual jaw size of each patient (jaw shape in the anterior region can also be specified)</li> <li>Automatic exposure control</li> <li>Spinal column compensation via automatic kV increase</li> </ul>
<ul style="list-style-type: none"> <li>"Quickshot" mode for Panorama and Ceph</li> </ul>
<ul style="list-style-type: none"> <li>CCD sensor technology with high-speed interface, 27-µm pixel size and image acquisition in 16-bit technology</li> <li>Combination Pan/Ceph and TSA sensors (optional)</li> </ul>
<ul style="list-style-type: none"> <li>Integrated power computer and Can-Bus architecture</li> <li>Upgradable software</li> <li>Touch screen with nearly endless software upgrade possibilities</li> </ul>
<ul style="list-style-type: none"> <li>Ceph is upgradable</li> <li>Transversal Section Acquisition (TSA) upgradable</li> </ul>
<ul style="list-style-type: none"> <li>Two versions available: ORTHOPHOS XG<sup>Plus</sup>, ORTHOPHOS XG<sup>Plus</sup> Ceph</li> </ul>
<ul style="list-style-type: none"> <li>SIDEXIS XG image management and analysis software</li> </ul>
<ul style="list-style-type: none"> <li>Optional baseplate</li> </ul>
<ul style="list-style-type: none"> <li>Suitable for patients in wheelchairs</li> </ul>

Programs
<p><b>Panorama programs:</b></p> <ul style="list-style-type: none"> <li>Standard panorama (P1)</li> <li>Standard panorama without ascending branches (P2)</li> <li>Pediatric program</li> </ul> <p>Each available as:</p> <ul style="list-style-type: none"> <li>Standard image</li> <li>Constant magnification (1.25:1)</li> <li>Artifact-free</li> <li>Sectional exposure choices</li> <li>Thick layer in the anterior region for anomalies (P12)</li> </ul>
<p><b>Lateral temporomandibular programs:</b></p> <ul style="list-style-type: none"> <li>With open and closed occlusion</li> <li>Single layer</li> <li>Multilayer</li> </ul>
<p><b>Axial temporomandibular programs:</b></p> <ul style="list-style-type: none"> <li>With open and closed occlusion</li> <li>Single layer</li> </ul>
<p><b>Sinus programs:</b></p> <ul style="list-style-type: none"> <li>Maxillary sinus (two images on one film)</li> <li>Paranasal sinus</li> </ul>
<p><b>Program for posterior teeth:</b></p> <ul style="list-style-type: none"> <li>Transversal multilayer</li> </ul>
<p><b>Cephalometric programs:</b></p> <ul style="list-style-type: none"> <li>Ceph asymmetrical</li> <li>Ceph symmetrical p.a.</li> <li>Ceph symmetrical a.p.</li> <li>Carpus/(Hand/Wrist)</li> </ul> <p>Additional projections possible</p>
<p><b>Optional: transversal layers based on wide-beam tomography (TSA)</b></p> <ul style="list-style-type: none"> <li>10 programs with thin layers</li> </ul>

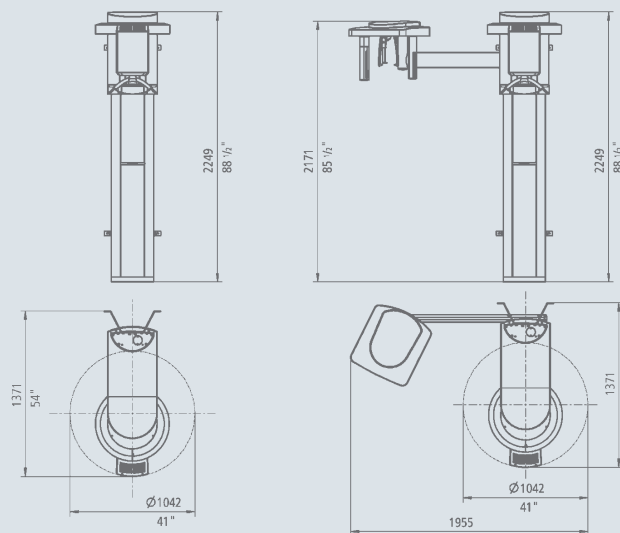

ORTHOPHOS XG<sup>Plus</sup>  
Space needed: min. 1280 x min. 1411 mm (min. 50.4" x min. 55.6")

ORTHOPHOS XG<sup>Plus</sup> Ceph  
Space needed: min. 2155 x min. 1411 mm (min. 84.8" x min. 55.6")

# Sirona – creating and maintaining value.

Treatment centers
Handpieces
Hygiene systems
X-ray systems
CEREC

*Logical.* You are right to expect a great deal from the world's only full-range supplier of dental equipment – in particular, an extensive product portfolio, first-class service, outstanding quality and tremendous value for money. Sirona covers the entire dental equipment spectrum: treatment centers, handpieces, X-ray systems, hygiene systems, imaging systems and – last but not least – CEREC ceramic restoration systems. Building products that stand the test of time, Sirona is the professional partner for the dental profession.

Treatment centers



Patient communication



X-ray systems



CEREC



Handpieces



Hygiene systems



Dealer's stamp

Sirona Dental Systems GmbH  
Fabrikstrasse 31 · D-64625 Bensheim  
E-mail: [contact@sirona.de](mailto:contact@sirona.de)  
[www.sirona.com](http://www.sirona.com)